

Wi-Fi SMART GARAGE DOOR OPENER

USER MANUAL

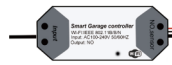

Smart Garage Controller

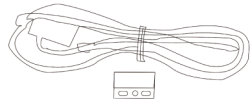

Door sensor



Line Holds



Sticker



Ties



Brackets



Wall Nails



Screws

⚠️ Test Device For Opener Compatibility

1. Power up the garage controller, The red light and blue light flash alternatively.
2. Use the included Red & Black wire connect the device to your opener:
Put each end to the same terminals as the wall button wires are terminated to.
3. Use a tiny screw or nail to click the button in the device, your garage door should activate.

*The Motor and Wall console are not included in the package.

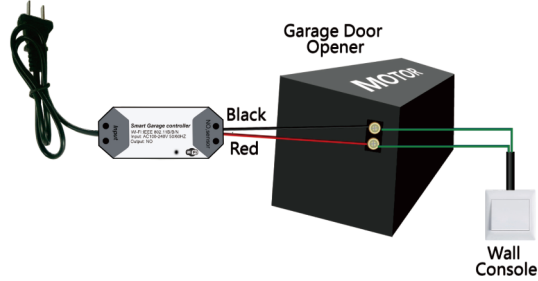

If this test fails, Your device may not be compatible, For additional installation instructions and the list of compatible models, please check it from other's user manual and contact us online directly

Test OK! Click the button every time, the garage door will open or close.

Below are checklist before using the device:

- Your smart phone or tablet should have connected a 2.4G WiFi with internet.
- The device only supports 2.4G Wi-Fi. If you use a 5G router (it provides two WiFi signals: 5G and 2.4G), please select the 2.4G WiFi to connect your smart phone.
- Download one of the APPs: "Tuya Smart" APP or "Smart Life" APP from APP Store or Google Play store.
- Durina Dairina Process. mgke sure that your ios or Android device and the Garage controller are within the range of your WiFi router.
- Make sure your router is MAC-open. If not, please cancel the router's MAC filtering setting first.

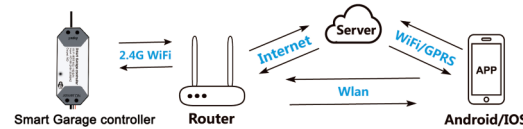

* Install the "Tuya Smart" APP or "Smart Life" APP.

Add Device

*The garage door will be activated when added successfully (when the blue LED stop blinking), so keep your door closed first.

1. Power up the garage, the red light and blue light flash alternately.
2. Ensure your cell phone connect with wifi network
3. Launch APP, Tap the icon "+" on the right top.
4. Select the "Electrical" --- Select "Wall Switch" type
5. Tap "Confirm indicator rapidly blink".
6. Input the correct 2.4G wifi password, then, tap confirm
7. It will auto-connect with the device. Once the process is completed, it will prompt you rename the device, Enter a new name and Save

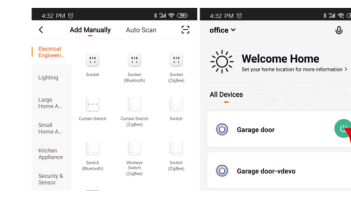

ON: The door is open. You can tap the icon to turn off.
OFF: The door is close. You can tap the icon to turn on.
Offline: Fail to control.

Tap here to enter the full function operation interface.

* The APP can add many types of devices.

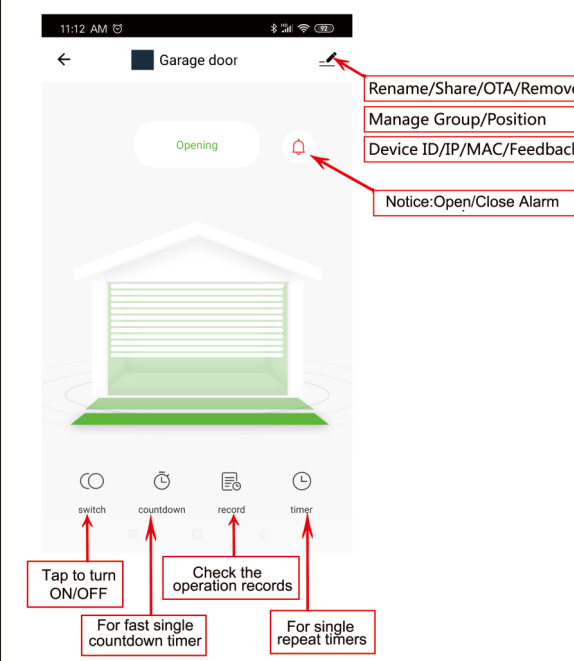

⚠️ Do this installation After you successfully added the device to your app.

*Keep your garage door is closed.
EASY INSTAL .LATION

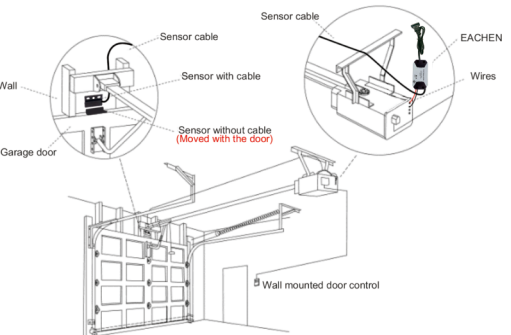

1st Step : Power up.

2nd Step : Connect to the wall console.

Insert the Red & Black wire 2.0mm terminal to the garage, then put each end to the same terminals as the wall button wires are terminated to.

3rd Step : Connect to the garage door.

Insert the 2.0mm terminal of the sensor to the garage, then steady install the sensor and the magnet of the gap within 3mm to 15mm on your garage door with screws/bracket/3M gums/wall nail/line holders/ties.

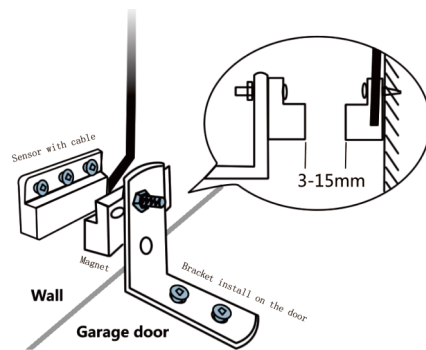

If it is hard to install with screws, you can also use the 3M gums to finish. If you are worried about the steady, you can use both screws and 3M gums.

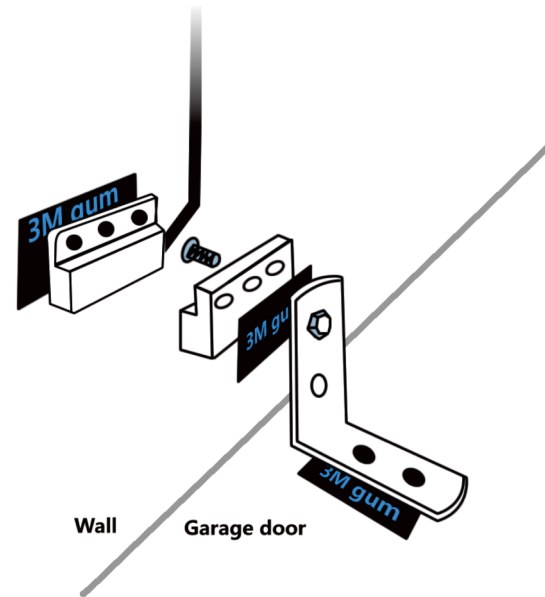

Works With Alexa



1. Open Alexa App, tap on the menu on upper left corner. Go to Skills.
2. Enter "Tuya Smart" or "Smart Life" in the search field and search.
3. Tap "Tuya Smart" or "Smart Life"
4. Enable the skill.
5. Enter your account information and tap on 'Log in' to link your account to your Amazon account. If your account is a phone number, you should select your country. If your account is an email address, please select a random country/region code.

Voice commands:
"Alexa, Open {device name}"
"Alexa, Close {device name}"
"Alexa, Is {device name} open?"



Works With Google Home



1. Launch Google Home app, tap the menu.
2. Tap Home control.
3. Under Devices, tap the + icon.
4. Tap "Tuya Smart" or "Smart Life"
5. Enter your account information and tap on 'Log in' to link your account to your Amazon account. If your account is a phone number, you should select your country. If your account is an email address, please select a random country/region code.

Voice commands:
"Hey google, turn on {device name}"
"OK google, turn off {device name}"



Works With IFTTT



1. Launch IFTTT app, tap Search. Enter "Tuya Smart" or "Smart Life" to search.
2. Enter "Tuya Smart" or "Smart Life" page.
3. Then you'll need to enter account and log in.
4. Go to My Applets, tap "+" to create your own applet.

Installation will be quick and easy and should take about 30 minutes to complete. For additional installation instructions, please contact with us.